

### Limiting Dimensions

### Plan view for all lever on long plate designs

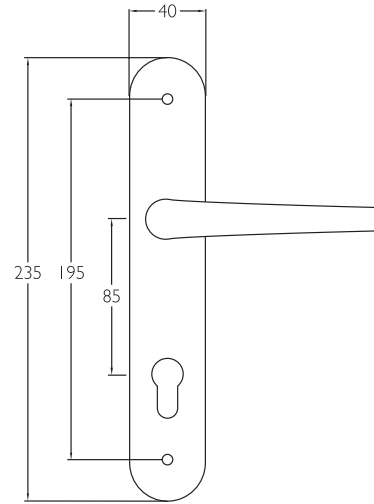

**9746E**

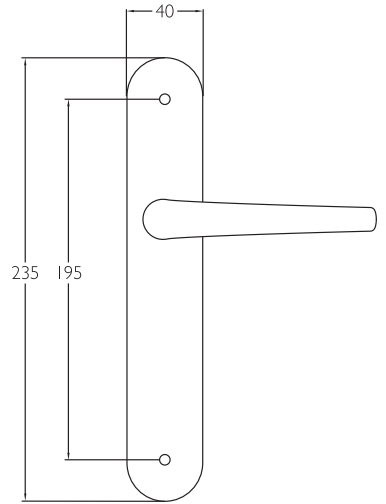

**9746P**

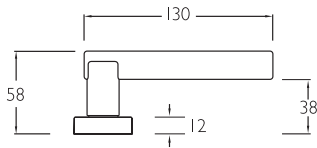

**9713E  
9713P**

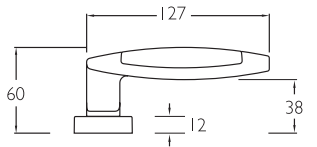

**9742E  
9742P**

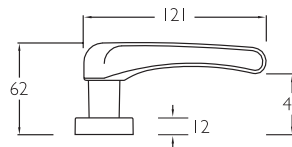

**9731E  
9731P**

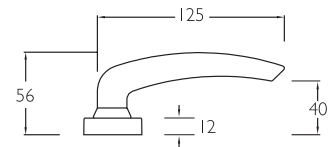

**9732E  
9732P**

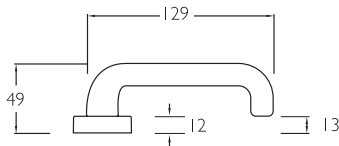

**9745E\*  
9745P\***

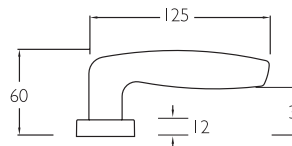

**9743E  
9743P**

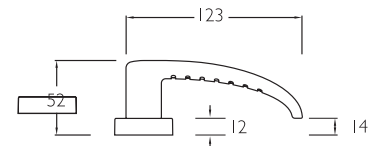

**9744E\*  
9744P\***

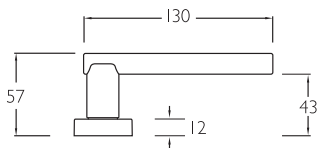

**9748E  
9748P**

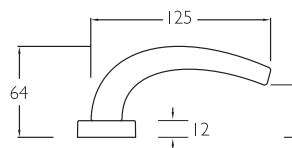

**9746E  
9746P**

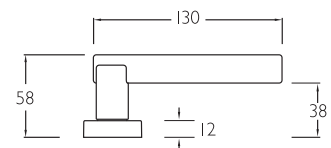

**9747E  
9747P**

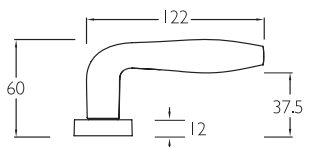

**9760E  
9760P**

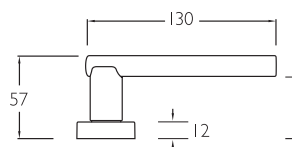

**9749E  
9749P**

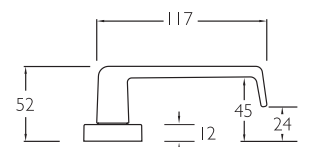

**9750E\*  
9750P\***

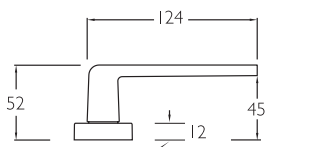

**9765E  
9765P**

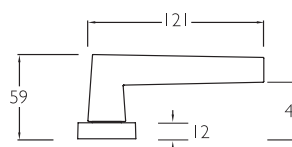

**9761E  
9761P**

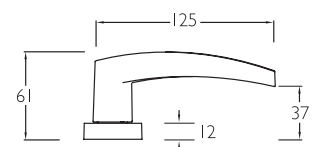

**9762E  
9762P**

The 9700 Series exterior sets suit the Gainsborough '755' Series mortice locks.

Passage sets suit the Gainsborough '480' or '960/980' Series dual sprung tubular latches.

\*Denotes lever meets access and mobility requirements of the Building Codes of Australia as defined in AS 1428.1-1993 Clause 11.1.1