



Vestible mortice locks and latches.
Available in a range of functions for egress application.
Locks are deadlatched upon closing of door.

Finishes

- SS** Stainless Steel
- PB** Polished Stainless Steel
- PS** Polished Brass

When ordering, add relevant finish code to form complete catalogue number.

List escutcheons and turnbuttons separately – Refer to page 3.15, 3.25 and 3.30.

Latchbolt

14mm Standard latchbolt

Backsets Available

23mm.

Special Keying

Each locking function can be specially keyed in a Gainsborough 6 pin tumbler system to meet the needs of commercial or residential building requirements. Locks can be keyed alike, master keyed, grand master keyed, maison keyed and project keyed – Refer to page 1.5 for details.

GR9 Profile also available for keying to residential series locksets.

Limiting Dimensions

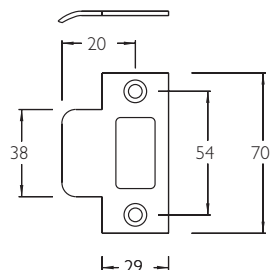
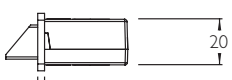
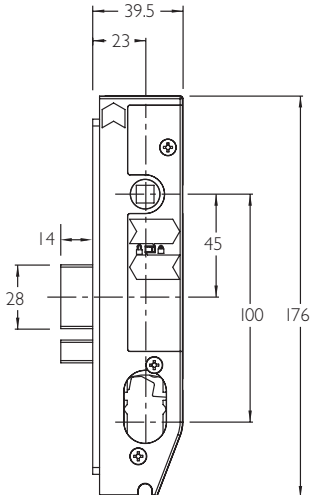
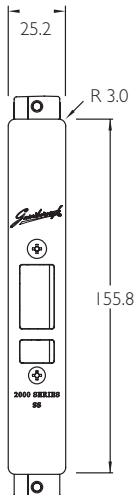

2000/SP01
32mm UNIVERSAL STRIKE

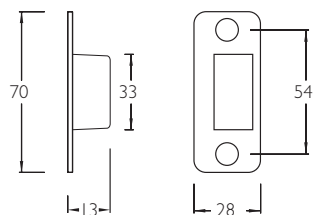

2000/SB01

2400 Series Mortice Vestibule Deadlatching Locks

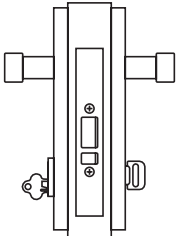
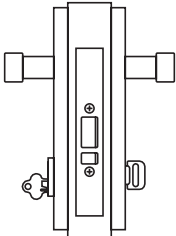
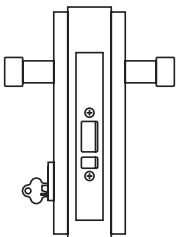
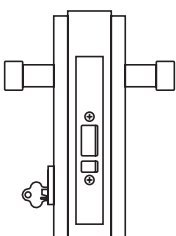
PRODUCT	DESCRIPTION	CATALOGUE NO.
<p>Entrance Office Lock</p> 	<p>Cylinder and Turnbutton.</p> <p>Latchbolt operated by handles either side. Outside handle is locked or unlocked by either key from outside or turnbutton inside.</p> <p>Inside handle always free for immediate exit.</p> <p>Auxiliary bolt deadlatches when door is closed.</p>	<p>24JA</p>
<p>Entrance Office lock (With dual function)</p> 	<p>Cylinder and Turnbutton.</p> <p>Latchbolt operated by handles either side. Outside handle is locked or unlocked by either key from outside or turnbutton inside.</p> <p>Key from outside can be rotated thus retracts latchbolt or unlocks outside handle. (A counter action for vandalism to outside handle).</p> <p>Inside handle always free for emergency exit.</p> <p>Auxiliary bolt deadlatches when door is closed.</p>	<p>24KA</p>
<p>Classroom Lock Single Cylinder (With dual function)</p> 	<p>Cylinder Outside.</p> <p>Latchbolt operated by handles either side. Outside handle is locked or unlocked by key from outside.*</p> <p>Inside handle always free for immediate exit.</p> <p>Auxiliary bolt deadlatches when door is closed.</p> <p>*Key outside can be rotated either way, thus retracts latchbolt or unlocks outside handle.</p>	<p>24KO</p>
<p>Classroom Lock</p> 	<p>Cylinder Outside.</p> <p>Latchbolt operated by handles either side. Outside handle is locked or unlocked by key from outside.</p> <p>Inside handle always free for immediate exit.</p> <p>Auxiliary bolt deadlatches when door is closed.</p>	<p>24VO</p>

Finish Codes: **PB** Polished Brass **PS** Polished Stainless Steel **SS** Stainless Steel

Note: Add finish code to above to form complete catalogue number e.g. 24JA PB

2400 Series Mortice Vestibule Deadlatching Locks

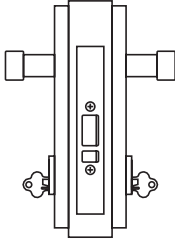
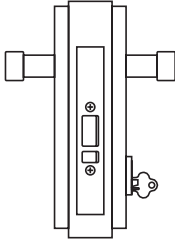
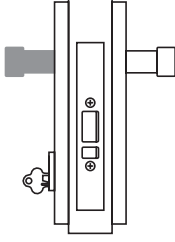
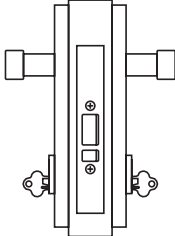
PRODUCT	DESCRIPTION	CATALOGUE NO.
<p>Exit Lock Double Cylinder</p> 	<p>Double Cylinder.</p> <p>Latchbolt operated by handles either side. Outside handle is locked or unlocked by key from inside. Outside cylinder retracts latchbolt.</p> <p>Inside handle always free for immediate exit.</p> <p>Auxiliary bolt deadlatches when door is closed.</p>	24CV
<p>Exit Lock Single Cylinder</p> 	<p>Cylinder Inside.</p> <p>Latchbolt operated by handles either side. Outside handle is locked or unlocked by key from inside.</p> <p>Inside handle always free for immediate exit.</p> <p>Auxiliary bolt deadlatches when door is closed.</p>	24OV
<p>Entry & Storeroom Door</p> 	<p>Cylinder Outside.</p> <p>Key outside retracts latchbolt. Outside handle is rigid at all times.</p> <p>Inside handle always free for immediate exit.</p> <p>Ideal for use with electric strike (ES1000 12 or 24 volt).</p> <p>Auxiliary bolt deadlatches when door is closed.</p>	24CO
<p>Double Cylinder</p> 	<p>Double Cylinder.</p> <p>Latchbolt operated by handles either side. Outside handle is locked or unlocked by key from both sides.</p> <p>Inside handle always free for immediate exit.</p> <p>Auxiliary bolt deadlatches when door is closed.</p>	24VV

Finish Codes: **PB** Polished Brass **PS** Polished Stainless Steel **SS** Stainless Steel

Note: Add finish code to above to form complete catalogue number e.g. 24VO PS

2400 Series Mortice Vestibule Deadlatching Locks

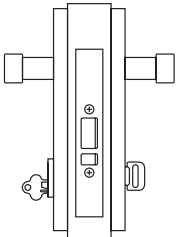
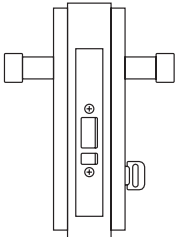
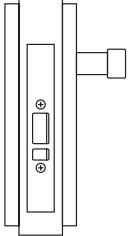
PRODUCT	DESCRIPTION	CATALOGUE NO.
<p>Entrance Office Lock</p> 	<p>Cylinder and Turnbutton.</p> <p>Latchbolt operated by handles either side. Outside handle is locked or unlocked by turnbutton inside. Key outside retracts latchbolt.</p> <p>Inside handle always free for immediate exit.</p> <p>Auxiliary bolt deadlatches when door is closed.</p>	<p>24CA</p>
<p>Exit Latch</p> 	<p>Turnbutton Inside.</p> <p>Latchbolt operated by handles either side. Outside handle is locked or unlocked by turnbutton inside.</p> <p>Auxiliary bolt deadlatches when door is closed.</p>	<p>24OA</p>
<p>Exit Latch</p> 	<p>No cylinder or turnbutton.</p> <p>Latchbolt operated by handles inside. No outside handle.</p> <p>Auxiliary bolt deadlatches when door is closed.</p>	<p>24EO</p>

Finish Codes: **PB** Polished Brass **PS** Polished Stainless Steel **SS** Stainless Steel

Note: Add finish code to above to form complete catalogue number e.g. 24VO PS